

1 2 3 4 5 6 7 8 9 10

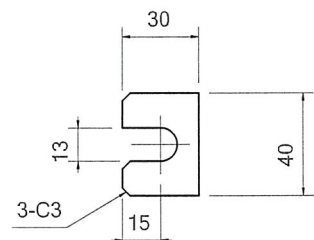

DETAIL A
SCALE 1 : 2

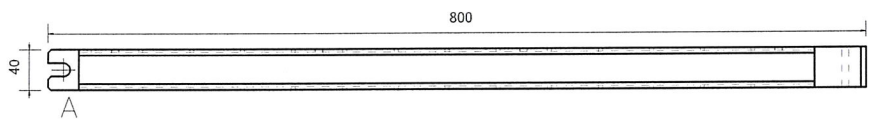
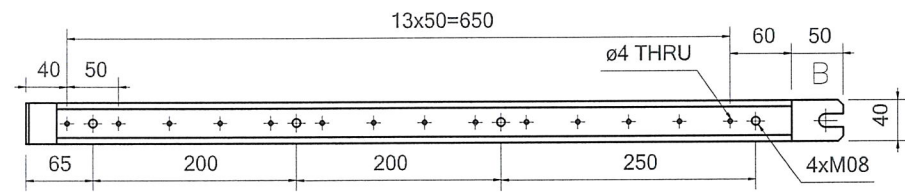
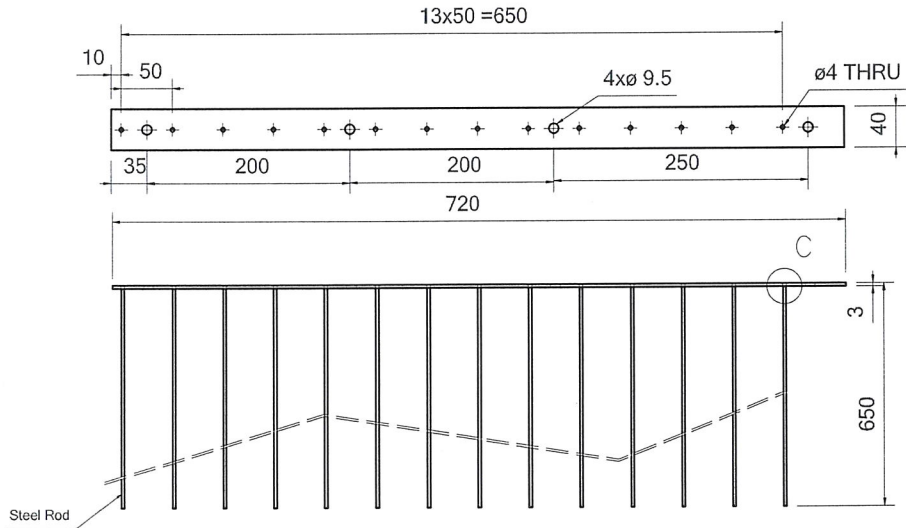
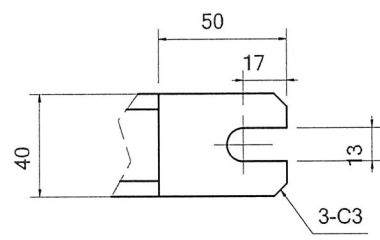

DETAIL B
SCALE 1 : 2

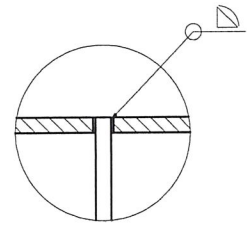

DETAIL C
SCALE 1 : 5

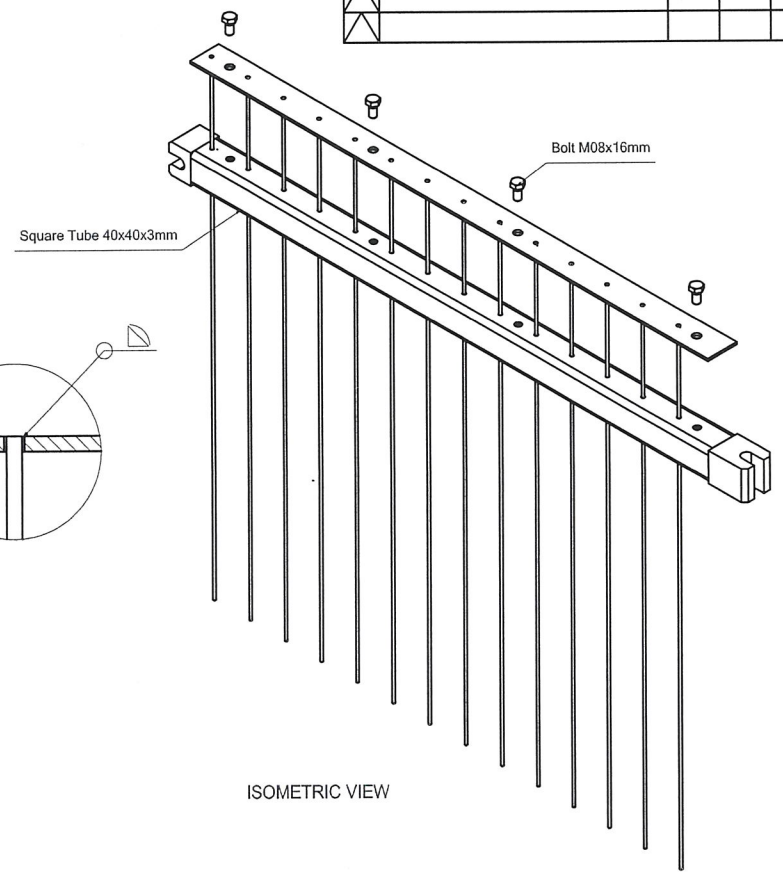

ISOMETRIC VIEW

100Z / (25Z / 6.3Z /)
C0.5 (C10)

SYM	REVISION RECORD	ISSUE NO	DATE	DR
△				
△				
△				

SURFACE TREATMENT	HEAT TREATMENT	MASS	UNIT
PAINTING		0.56	Kg
MATERIAL	RESEMBLANCE PART NO.	MPO CODE	EO CODE
SQ TUBE 40x40 & SS400			

PART NAME	DR SIZE	SP CODE	SHEET
NAIL ASSY	A3	P	1/1
PT TRIWINATA INDONESIA	2012-DWG-MCA-GR-M-001-22	Qty : 20	SCALE 1/1
APPROVED	CHECKED	DESIGNED	DRAWN
TWI	TWI	TWI	NOP
REMARK: PART NO.		AUTOMATIC GAS RELEASE	

27-Jan-20 20 27/Jan-20

CONFIDENTIAL