

**SCG****PT. SCG LIGHTWEIGHT CONCRETE INDONESIA**

JL. Surya Tekno KAV I-T1-3 Suryacipta City Of Industry,

Kutamekar, Ciampel Jawa Barat 41361 Indonesia

Phone : 0267-8610361

Fax : 0267-8610360

N.P.W.P : 31.567.302.0-433.000

PURCHASE ORDER

To : PT. PRO ROLL INTERNATIONAL
Taman Kopo Indah III E16-186
Bandung
Indonesia

PO No. : 4021012581
PO Date : 11.08.2022
PO Currency : IDR

Phone : 02288887510
Fax : 02288887511
N.P.W.P : 023666761422000

Please supply the following item

No.	Material Code	Item Description	Qty	Unit	Delivery Date	Unit Price	Total Amount	Discount
10	K16A07024	Sponge Gripper Unloader	4	PC	31.08.2022	2,200,000 / 1	8,800,000	0



Delivery To : PT SLCI
JL. Surya Tekno KAV I-T1-3 Suryacipta City Of Industry,
Karawang 41361 Indonesia

Total Prices 8,800,000
PPN (VAT) 968,000
Grand Total 9,768,000

Term of Payment : Credit 30 days after received bill

Remarks : PR 1021012226

Barang yang tidak sesuai spesifikasi akan kami kembalikan
Wajib mematuhi aturan keselamatan selama berada di PT. SLCI

Prepared By	Checked By	Approved By	Confirmed By (Vendor)
 Arfandi			



Price Comparison Form

Price Investigation
 Acquisition by Tender

Raw Material
 Supply
 Made to Order

Services
 Other.....

No. PC A2403

No.	Description	Quantity	Last price / Standard Price		PT Pro Roll International		CV. Sumber Mandiri Utama		Last Order					
			As At.....		c/o Mr. Yayang		c/o Mr. Kamal		Supplier: PT Pro Roll International					
			Price	Supplier Name	Price	Delivery	Price	Delivery	Price	Delivery	Price	Date	Remarks	
1	Sponge Gripper Unloader 2012-DWG-PPL-SG-M-011	6 pcs	Rp13.200.000	PT Pro Roll International	Rp2.200.000		Rp7.500.000					Rp2.200.000	5/30/2022	
			Rp13.200.000											

Reason : repeat order

Require Approval not to Sign Contract Because Good History Supplier

Verbal Price Investigation and Documented
 Price Negotiation
 Price investigation and Verbal Offering Price
 Documented price investigation and documented Offering Price
 Special Acquisition

Lowest Price / Former Price
 Quality
 Delivery
 Monopoly

Urgently
 Acquire From Specific Source
 Acquire From Affiliate
 Urgently

Prepared by : Arfandi K. Date : 08-10-2022	Committee of Opening the Seal Price / Price Investigator Date	Acknowledge by: Section Manager Date	Acknowledge by: Plant Manager Date
--	---	--	--

PURCHASE REQUEST CHECK APPROVAL

ITEM DESCRIPTION

PR Number : 1021012226
Total Price : IDR 8,177,276
Attachment : [Click here \(https://iot.slci.co.id/assets/lampiranpr/PR_1021012226.JPG\)](https://iot.slci.co.id/assets/lampiranpr/PR_1021012226.JPG)

Details PR

No.	Item	A	Material	Short Text	Quantity	Unit	Delivery Date	Plant	Matl.Group	PGR	Value
1	10		K16A07024	Sponge Gripper Unloader	4	PC	15.08.2022	PT SLCI	Spare Parts	DBA	8,177,276

Purpose:

[10] for gripping brick to separate product from hardening grate to tilting table (prevent chipping reject)

Dibuat Oleh, 90473(Wahyu Pebriyanto) 2022-07-15 10:49:16	Checked by, 90065(Nur Mustaqim) Approved at 2022-07-15 16:14:52	Budget Control, 90696(Mukhtar L) Approved at 2022-07-18 08:46:41	Approved by, 90156(Mochamad Nugrahaputra) Approved at 2022-07-19 09:15:47
---	--	---	--

ID Stock : K16A07024
CHECKED PASS
 "No. DWG" sesuai dengan "ID Stock" dalam lot.
 Checked : *[Signature]*
 Date : 15 / 10 / 20

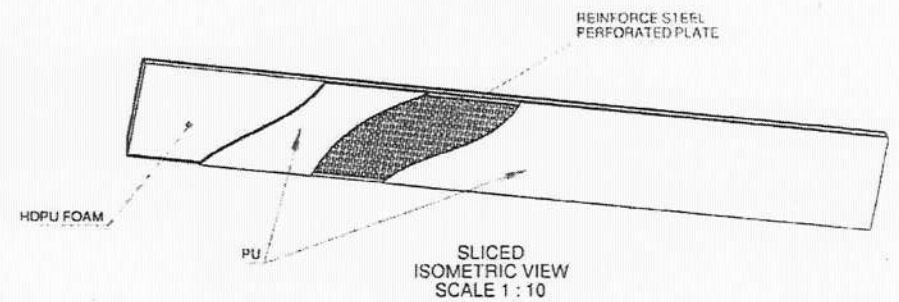
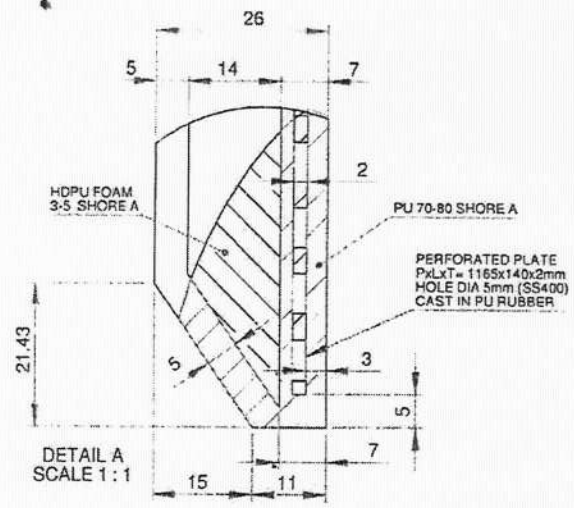
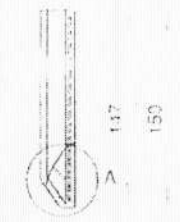
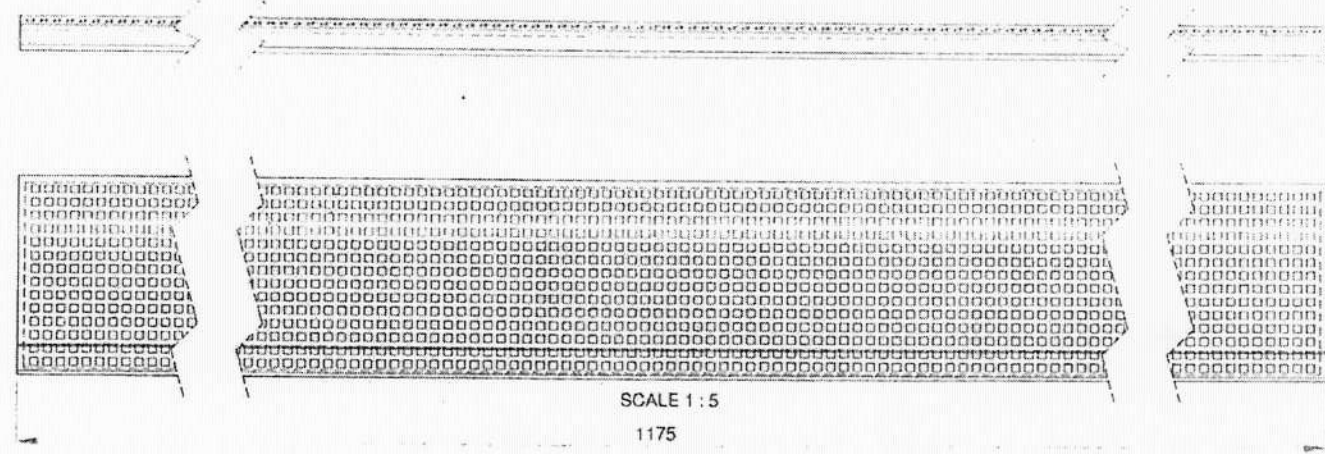

** INCOMING PART WILL BE CHECK. IT WILL RETURN IF NOT PASS **

POLISHING	GRINDING	NORMAL MACHINING (SMOOTH SURFACE)	NORMAL MACHINING (ROUGH SURFACE)
▽▽▽	▽▽	▽	▽

POS	DESCRIPTION	QTY	MATERIAL	REMARKS
FILE DIR: \\192.168.4.15\mechanical\Draft Nuryana\Proyek Pak Aji\Sponge Grieler		SCALE: 1:5 DIM: mm		ASSY NO.
MECHANICAL ENGINEERING SECTION				
DRAWN	ENDEN	DATE	TITLE PACKING	
DESIGN	AVAILABLE	1/10/2018		
CHECK	YESSIKO			
APRV	RULLY			
CANCEL DWG NO.				
REF DWG NO.				

SPONGE GRIPPER



PT. PRO ROLL INTERNATIONAL

Rubber Rollers Mfg - Rubber Recovering - Hard Chrome
 - Hard Anodize - Polyurethane - Teflon Coating
 Taman Kopo Indah Blok 16 no 188 Bandung 40218 Indonesia

Telp. 022-89867610 Fax 022-89897611 Email : sales@proroll.co.id Website: www.proroll.co.id

COMPANY	PT. SCG LIGHTWEIGHT CONCRETE INDONESIA	DATE	: 23 MEI 2022
FAX	: 0267-8610360	PAGE	: 1
ATTENTION	: Mr. ARFANDI KURNIAWAN	OUR REF	: PJ-043/V/22
CC	:		

QUOTATION - YOUR RFQ "SPONGE GRIPPER UNLOADER"

Dear Sir,
 Thank you for the inquiry and we are pleased to submit our offer :

NO	NO MAT'L	DESCRIPTION	QUANTITY	PRICE	
				EACH	TOTAL
1		SPONGE GRIPPER UNLOADER - DIMENSI : AS PER DWG - DWG REF : 2012-DWG-PPL-SG-M-011 - MATERIAL : POLYURETHANE 70-80 SHORE A : PERFORATED PLATE - GUARANTEE : 1 MONTHS	6 pcs	Rp 2,250,000	Rp 13,500,000
		- Delivery Time : 6-8 WEEKS AFTER RECEIVED PO : FRC MILL SCG	DISKON	Rp (50,000)	Rp (300,000)
		- TERM OF Payment : Credit Note 30 DAYS after invoice	TOTAL	Rp 2,200,000	Rp 13,200,000
		- VAT (PPN) : Excluded PPN (11%)			

Thank you, for your kind attention and cooperation
 sincerely yours,

YAYANG HERYANTO
 (081 822 1581)



CV. SUMBER MANDIRI
UTAMA
Machining, Polyurethane,
Rubber, Silicone & Plastics

S P H
SURAT PENAWARAN HARGA

No. SPH : 1064/PH/SMU/V/2022
Tanggal : 30 Mei 2022

A. Biodata Workshop

CV. SUMBER MANDIRI UTAMA
Jl. Terusan Cibiuk No. 142 C Cangkang Wetan
Dayeuhkolot Kab. Bandung
Telp / Fax : (022) 5441 6778
Email : cs@sumbermandiritama.com
Marketing : Nur Mustopa Kamal
Mobile : 081 1234 6033

B. Biodata Customer

Kepada Yth.
Nama Perusahaan : PT. SCG Lightweight Concrete Indonesia
Alamat : Jl. Surya Tekno Kav. I-T1-3 Surya Cipta
Kabupaten Karawang, Jawa Barat 41361
Telp. : 0267-8610362
Fax. :
Email : arfandikurn@scg.com
Person : Bapak Arfandi Kurniawan

Dengan Hormat,

Berikut ini kami sampaikan penawaran harga untuk barang berikut dibawah ini :

C. Biodata Pekerjaan

Jenis pekerjaan :
Sub bidang :

No.	Deskripsi	Qty.	Harga Satuan (Rp)	Jumlah Harga (Rp)
1.	Sponge Gripper 1175x26x147mm	1 pc	7.500.000,00	7.500.000,00
Terbilang : Delapan Juta Tigaratus Duapuluh Lima Ribu Rupiah			Jumlah	7.500.000,00
			PPN 11%	825.000,00
			Jumlah Total	8.325.000,00

Spesifikasi/Keterangan :

Ruang Lingkup Kerja Umum (RLKU)

1. Inspeksi awal
2. Diskusi teknik
3. Pengadaan material
4. Proses produksi



Demikian surat penawaran harga ini kami sampaikan, dan kami tunggu kabar baik selanjutnya.
Atas perhatian dan kerjasamanya, kami ucapkan terima kasih.

D. Ketentuan

Proses kerja : 30 hari kerja
Pembayaran : 1 bulan
Franco : PT. SCG Lightweight Concrete Indonesia
Keterangan : Pekerjaan setelah PO/SPK diterima

Dibuat Oleh,

Disetujui Oleh,



CV. Sumber Mandiri
Utama
Nur M. Kamal