



PT. SCG LIGHTWEIGHT CONCRETE INDONESIA
JL. Surya Tekno KAV I-T1-3 Suryacipta City Of Industry,
Kutamekar, Ciampel Jawa Barat 41361 Indonesia
Phone : 0267-8610361
Fax : 0267-8610360
N.P.W.P : 31.567.302.0-433.000

PURCHASE ORDER

To : PT. S.A.N JAYA TEKNIK
JL. SADANG NO.121
BANDUNG 40225
Indonesia

PO No. : 4021012664
PO Date : 29.08.2022
PO Currency : IDR

Phone : 0225424694
Fax : 0225414583
N.P.W.P : 315840538445000

Please supply the following item



No.	Material Code	Item Description	Qty	Unit	Delivery Date	Unit Price	Total Amount	Discount
10	K16A06012	Lantern Ring 4/3 MST	2	PC	30.09.2022	1,050,000 / 1	2,100,000	0
20	K16A06011	Lantern Ring 6/4 MST	1	PC	30.09.2022	1,150,000 / 1	1,150,000	0

Delivery To : PT SLCI
JL. Surya Tekno KAV I-T1-3 Suryacipta City Of Industry,
Karawang 41361 Indonesia

Total Prices 3,250,000
PPN (VAT) 357,500
Grand Total 3,607,500

Term of Payment : Credit 30 days after received bill

Remarks : PR 1021012363, 1021012308
Barang yang tidak sesuai spesifikasi akan kami kembalikan
(10) 2012-DWG-MPL-MS43-M-001-13
(20) 2012-DWG-MPL-MS64-M-001-13

Prepared By	Checked By	Approved By	Confirmed By (Vendor)
 Arfandi			



Price Comparison Form

- Price Investigation
- Acquisition by Tender

- Raw Material
- Supply
- Made to Order

- Services
- Other.....

No. PC A2430

No.	Description	Quantity	Last price / Standard Price		PT. San Jaya Teknik		PT. Cipta Presisi Mandiri		PT Bintang Angkasa Anug		Last Order		
			As At.....		c/o Mrs. Githa		c/o Mr Farizal		c/o Mr. Benny		Supplier: PT. San Jaya Teknik		
			Price	Supplier Name	Price	Delivery	Price	Delivery	Price	Delivery	Price	Date	Remarks
1	Lantern Ring 4/3 MST 2012-DWG-MPL-MS43-M-001-13	2 pcs	Rp2.100.000	PT. San Jaya Teknik	Rp1.050.000		Rp1.150.000		Rp1.080.000		Rp1.050.000	8/9/2022	
2	Lantern Ring 6/4 MST 2012-DWG-MPL-MS64-M-001-13	1 pcs	Rp1.150.000		Rp1.150.000		Rp1.187.500				Rp1.150.000	6/21/2022	
			Rp3.250.000										

- Verbal Price Investigation and Documented
- Price Negotiation
- Price investigation and Verbal Offering Price
- Documented price investigation and documented Offering Price
- Special Acquisition
- Urgently
- Acquire From Specific Source
- Acquire From Affiliate
- Urgently

Reason : repeat order

- Lowest Price / Former Price
- Quality
- Delivery
- Monopoly

Require Approval not to Sign Contract Because Good History Supplier

Prepared by : Arfandi K. Date: 08-26-2022	Committee of Opening the Seal Price / Price Investigator Date:	Acknowledge by: Section Manager Date:	Acknowledge by: Plant Manager Date:
---	--	---	---

PURCHASE REQUEST CHECK APPROVAL

ITEM DESCRIPTION

PR Number : 1021012363
Total Price : **IDR 2,100,000**
Attachment : [Click here \(https://iot.slsi.co.id/assets/lampiranpr/PR_1021012363.JPG\)](https://iot.slsi.co.id/assets/lampiranpr/PR_1021012363.JPG)

Details PR

No.	Item	A	Material	Short Text	Quantity	Unit	Delivery Date	Plant	Matl.Group	PGR	Value
1	10		K16A06012	Lantern Ring 4/3 MST	2	PC	14.09.2022	PT SLCI	Spare Parts	DBA	2,100,000

Purpose:

[10] Stock for mechanical sparepart

Dibuat Oleh, 90473(Wahyu Pebriyanto) 2022-08-13 13:50:36	Checked by, 90065(Nur Mustaqim) Approved at 2022-08-15 08:48:50	Budget Control, 90696(Mukhtar L) Approved at 2022-08-16 15:30:44	Approved by, 90156(Mochamad Nugrahaputra) Approved at 2022-08-17 08:37:50
---	--	---	---

ID Stock : K16A06012
CHECKED PASS
 "No. DWG" sesuai dengan "ID Stock" dalam IoT.
 Checked : *[Signature]*
 Date : 15 / 10 / 20

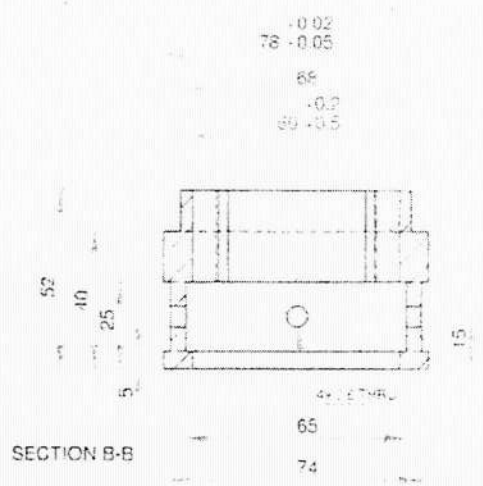
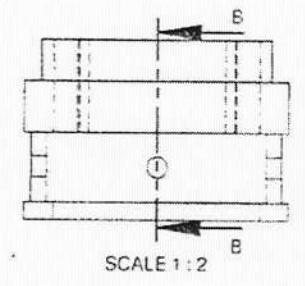
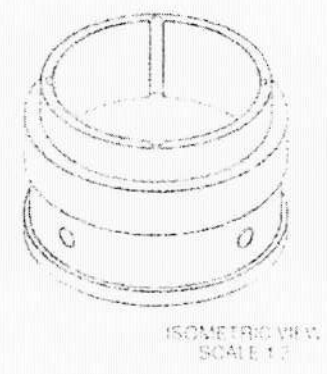
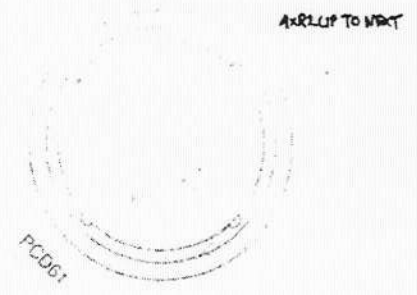

** IN-COMING PART WILL BE CHECK. IT WILL RETURN IF NOT PASS **

POLISHING	GRINDING	NORMAL MACHINING (SMOOTH SURFACE)	NORMAL MACHINING (ROUGH SURFACE)
<i>[Symbol]</i>	<i>[Symbol]</i>	<i>[Symbol]</i>	<i>[Symbol]</i>

1	LANTERN RING	1	BRONZE
POS	DESCRIPTION	QTY	MATERIAL
FILE DIR	1321634 15 mechanical Draft Nuryana Provok Pak Yessiko Pump MS 43		
SCALE	1:2	DWG/ mm	ASSY/ NO
DRW/ mm	NAME	DATE	TITLE
DRAWN	ENDEN	12/4/2012	SLURRY PUMP MS 43
DESIGN	SIGIT		
CHECK	YESSIKO		
APRV	RULLY		
CANCEL DWG NO			
REF DWG NO			
PT SOE LIGHTWEIGHT CONCRETE INDONESIA			
A4		2012-DWG-MPL-MS43-M-001-13	

LANTERN RING

PURCHASE REQUEST CHECK APPROVAL

ITEM DESCRIPTION

PR Number : 1021012308
Total Price : IDR 1,150,000
Attachment : [Click here \(https://iot.slci.co.id/assets/lampiranpr/PR_1021012308.JPG\)](https://iot.slci.co.id/assets/lampiranpr/PR_1021012308.JPG)

Details PR

No.	Item	A	Material	Short Text	Quantity	Unit	Delivery Date	Plant	Matl.Group	PGR	Value
1	10		K16A06011	Lantern Ring 6/4 MST	1	PC	09.09.2022	PT SLCI	Spare Parts	DBA	1,150,000

Purpose:

[10] For mechanical spare parts

Dibuat Oleh,
90473(Wahyu Pebriyanto)
2022-08-05 10:42:03

Checked by,
90065(Nur Mustaqim)
Approved at 2022-08-08 08:59:02

Budget Control,
90696(Mukhtar L)
Approved at 2022-08-08 18:36:25

Approved by,
90156(Mochamad Nugrahaputra)
Approved at 2022-08-10 09:56:07

SPH
SURAT PENAWARAN HARGA

No-SPH : 039/SPH/SJH/XII/2021
Tanggal : 11 Desember 2021

A. Biodata Workshop
PT. S.A.N Jaya Teknik
Jl. Sadang No. 164 Margahayu Bandung 40225
Telp : (022) 5404965, 5417604
Fax : (022) 5414583
Email : nandang_sanjaya184@yahoo.com
Website : www.sanjayateknik.com
Mobile : 0813 210909 08
0878 210909 19

B. Biodata Customer
Kepada Yth
Nama Perusahaan : PT. SCG Lightweight Concrete Ind.
Alamat : Surya Cipta City of Industry
Karawang - Indonesia
Telp. : (0267) 8610 362, 8610 363
Fax : (0267) 8610 360
Email : yoki@slci.co.id
Person : Bpk. Arfandi Kurniawan

Dengan Hormat,
Berikut ini kami sampaikan penawaran harga untuk barang berikut dibawah ini :

C. Biodata Pekerjaan

Jenis Pekerjaan : Manufaktur Fabrikasi Repair Modifikasi

Sub Bidang : Part/Komponen Sub Assy Complete Assy

confirmed by Bu Gittha 20/11

No.	Nama Barang	Qty	Sat	Harga Satuan (Rp)	Jumlah Harga (Rp)
1.	LANTERN RING 4/3 MST	1	Pcs	1.050.000 1.105.000	1.105.000
				Jumlah	1.105.000
<i>Terbilang : Satu Juta Dua Ratus Lima Belas Ribu Lima Ratus Rupiah</i>				PPN 10%	110.500
				Total	1.215.500

Spesifikasi/Dimensi/Keterangan

Ruang Lingkup kerja Umum (RLKU)

- Inspeksi Awal,
- Diskusi Teknik,
- Pengadaan material,
- Proses Produksi

Ruang Lingkup Kerja Produksi (RLKP)

- Cutting
- Drilling
- Turning
- Frais Milling
- Polishing

D. Sketsa / Catatan

1. TOLERANSI DIMENSI DAN GEOMETRIS SESUAI DENGAN STANDARD ISO
2. PT. Sanjaya Teknik akan mengajukan addendum harga apabila ada pekerjaan diluar ruang lingkup pekerjaan diatas

Demikian surat penawaran harga ini kami sampaikan, dan kami tunggu kabar baik selanjutnya. Atas perhatian, kepercayaan dan kerjasamanya yang baik selama ini, kami ucapkan terima kasih.

E. Ketentuan

Proses Kerja :
Pembayaran : Tempo 1 Bulan Setelah Barang Terkirim
Down Payment (DP) : -
Validasi Penawaran : 1 Minggu
Keterangan : Pekerjaan setelah DP, PO/SPK diterima

Dibuat Oleh,

(Gittha Yuliana)

Diketahui Oleh,

(Nandang Sophian)

SPH
SURAT PENAWARAN HARGA

No SPH : 043/SPH/SJ/ XII/2021
Langgal : 27 Desember 2021

A. Biodata Workshop
PT. S.A.N Jaya Teknik
Jl. Sadang No. 164 Margahayu Bandung 40225
Telp : (022) 5404965, 5417604
Fax : (022) 5414583
Email : nandang_sanjaya184@yahoo.com
Website : www.sanjayateknik.com
Mobile : 0813 210909 08
0878 210909 19

B. Biodata Customer
Kepada Yth
Nama Perusahaan : PT. SCG Lightweight Concrete Ind.
Alamat : Surya Cipta City of Industry
Karawang - Indonesia
Telp. : (0267) 8610 362, 8610 363
Fax : (0267) 8610 360
Email : yoki@slci.co.id
Person : Bpk. Arfandi Kurniawan

Dengan Hormat,
Berikut ini kami sampaikan penawaran harga untuk barang berikut dibawah ini :

C. Biodata Pekerjaan

Jenis Pekerjaan : Manufaktur Fabrikasi Repair Modifikasi
Sub Bidang : Part/Komponen Sub Assy Complete Assy

confirmed by Bu Giha 18/6

No.	Nama Barang	Qty	Sat	Harga Satuan (Rp)	Jumlah Harga (Rp)
1.	LANTERN RING 6/4 MST	2	Pcs	1.150.000 1.339.000	2.678.000
				Jumlah	2.678.000
<i>Terbilang : Dua Juta Sembilan Ratus Empat Puluh Lima Ribu Delapan Ratus Rupiah</i>				PPN 10%	267.800
				Total	2.945.800

Spesifikasi/Dimensi/Keterangan

Ruang Lingkup kerja Umum (RLKU)

- Inspeksi Awal,
- Diskusi Teknik,
- Pengadaan material,
- Proses Produksi

Ruang Lingkup Kerja Produksi (RLKP)

- Cutting
- Drilling
- Turning
- Frais Milling
- Polishing

D. Sketsa / Catatan

1. TOLERANSI DIMENSI DAN GEOMETRIS SESUAI DENGAN STANDARD ISO
2. PT. Sanjaya Teknik akan mengajukan addendum harga apabila ada pekerjaan diluar ruang lingkup pekerjaan diatas

Demikian surat penawaran harga ini kami sampaikan, dan kami tunggu kabar baik selanjutnya. Atas perhatian, kepercayaan dan kerjasamanya yang baik selama ini, kami ucapkan terima kasih.

E. Ketentuan

Proses Kerja :
Pembayaran : Tempo 1 Bulan Setelah Barang Terkirim
Down Payment (DP) :-
Validasi Penawaran : 1 Minggu
Keterangan : Pekerjaan setelah DP, PO/SPK diterima



Diketahui Oleh,

(Nandang Sophian)



PT. CPM
Jl. Raya Siliwangi No. 100, Gedung 100, Lantai 10
Kawasan Industri, Bandung
Jl. Raya Siliwangi No. 100, Gedung 100, Lantai 10
Bandung, Jawa Barat 40132
Telp. (022) 253 7468 - 253 9131 Fax (022) 253 7468
Mobile (081) 4678 101
E-mail: cpm@indone.sia.yahoonline.id

Jakarta 14 Maret 2022

Nomor : 117/CPM/III/22/SLCI/008

Hal : Penawaran Harga

Kepada

PT. SCG Lightweight Concrete Indonesia
Jl. Surya Tekno Kav. I, T1-3 Surya Cipta
Karawang, Jawa Barat 41361

Up. Bp. Yoki Radiansyah

Telp. (0267) 8610362

Dengan hormat,

Bersama ini kami sampaikan penawaran harga untuk pembuatan part standard sesuai dengan gambar yang kami terima, adalah sebagai berikut:

No.	Part Name	Mtrl	Qty	Harga	Jumlah
1	Lantern Ring 4/3 MST Dia 78 x 52	Bronze	1 Pcs	1,200,000	Rp 1,200,000
TOTAL					Rp 1,200,000

* Harga diatas belum termasuk PPN 10 %

Keterangan:

- Delivery : ± 2 - 4 Minggu setelah PO diterima
- Pembayaran : 2 Minggu setelah barang diterima
- Penawaran ini berlaku selama 1 minggu

1.500.000

confirmed by

Pak Farizal

14/3

Demikian surat penawaran ini kami buat. Atas perhatian dan kerjasamanya kami ucapkan terima kasih.

Hormat kami,



Farizal



PT. PERTAMINA (P.T.)
Bidang Operasi & Pemeliharaan - KAWANANG
Jl. Raya Karawang - KAWANANG - JAWA BARAT
Telp. (0267) 2537400, 2537405, 2537406, 2537407, 2537408
Mobile (0812) 1978 000
Email: cpman@pmp.siv.valeo.com

Jakarta 27 Desember 2021

Nomor : 502/CPM/XII/21/SLCI/067

Hal : Penawaran Harga

Kepada

PT. SCG Lightweight Concrete Indonesia

Jl. Surya Tekno Kav. I-TI-3 Surya Cipta

Karawang, Jawa Barat 41361

Up. Bp. Arfandi Kurniaan

Telp. (0267) 8610362

Dengan hormat,

Bersama ini kami sampaikan penawaran harga untuk pembuatan part standard sesuai dengan gambar yang kami terima, adalah sebagai berikut:

1.187.500 Confirmed by Pak Farizal

29/12-21

No.	Part Name	Mtrl	Qty	Harga	Jumlah
1	Lantern Ring 6/4 MST Dia 108x34.5	Bronze	2 Pcs	1.250,000	Rp 2,500,000
2	Shaft Sleeve 4/3 MST 52mm Dia 60x52	DC 53 HRC 52-57	4 Pcs	975,000	Rp 3,900,000
TOTAL					Rp 6,400,000

* Harga diatas belum termasuk PPN 10 %

Keterangan:

- Delivery : ± 2 - 4 Minggu setelah PO diterima
- Pembayaran : 2 Minggu setelah barang diterima
- Penawaran ini berlaku selama 1 minggu

Demikian surat penawaran ini kami buat. Atas perhatian dan kerjasamanya kami ucapkan terima kasih.

Hormat kami,

Farizal



PT. BINTANG ANGKASA ANUGERAH

Dusun Kawali No 38 RT/RW 72/20
Desa Duren Kec. Klari - Karawang
Telp & Fax : 0267 8618459

Tanggal : Karawang, 14 Maret 2022
No. : 25/BAA/III/22
Perihal : Penawaran Harga

Kepada Yth,
PT. SCG LIGHTWEIGHT CONCRETE IND
KARAWANG
Telp : 0267-8610361
Fax : 0267-8610360
U/p : Bpk. Yoki / Bpk. Arfandi

Dengan hormat,

Terima kasih atas permintaan harga dari Bapak/Ibu untuk pembuatan barang di bawah ini. Dengan ini kami kirimkan penawaran harga sebagai berikut :

No	Nama Barang	Qty	Harga Satuan	Total Harga
1.	Lantern Ring	2 Pcs	Rp 1.200.000	Rp 2.400.000

Ruang Lingkup pekerjaan PT. Bintang Angkasa Anugerah : 1.080.000

- Pembuatan Baru

*confirmed by
Pak Benny
14/3.*

Kondisi Penawaran

1. Pengiriman : PT. SLCI
2. Pembayaran : 1 (satu) bulan setelah barang dikirim
3. Pajak : Belum termasuk

Demikian penawaran harga dari kami, semoga sesuai dengan Budget yang Bapak/Ibu anggarkan. Atas perhatian dan kerjasamanya kami ucapkan terima kasih.

Hormat kami,
PT. Bintang Angkasa Anugerah

(Gunawan)